

A

B

C

D

E

F

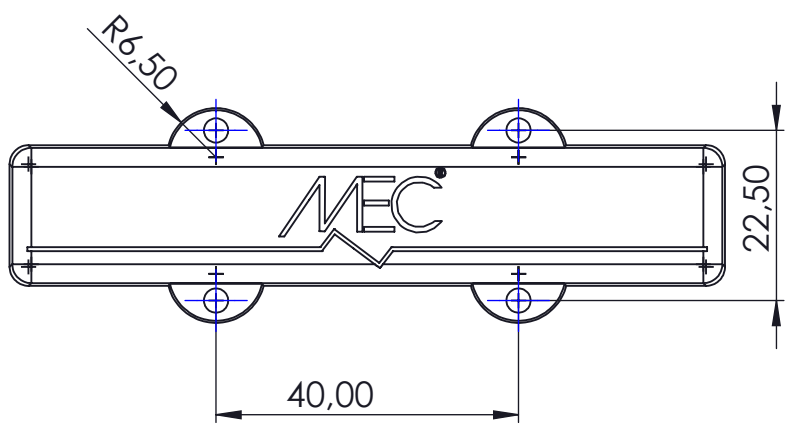
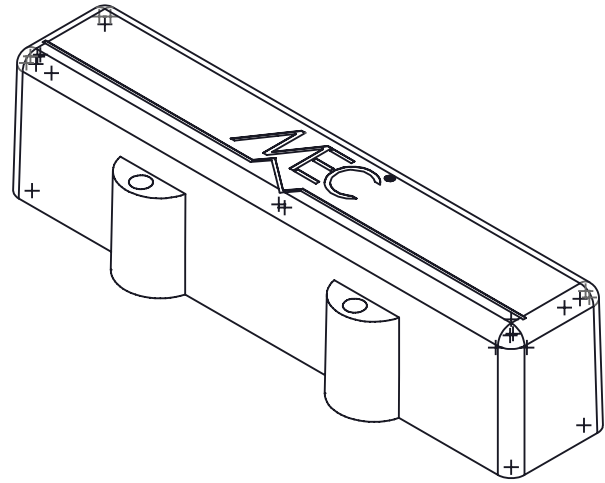

M 60101 L

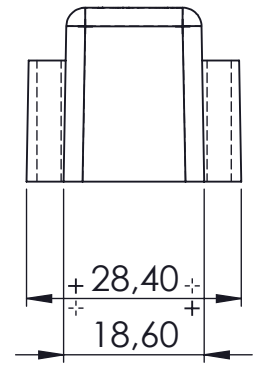
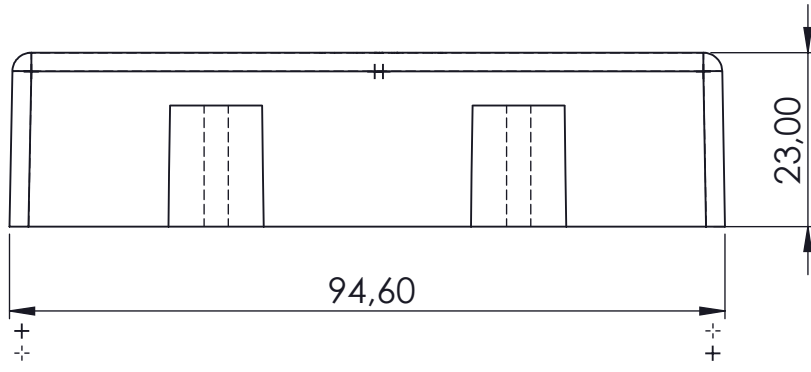

Warwick Gmbh & Co Music Equipment KG
 Gewerbepark 46
 D-08258 Markneukirchen
 Tel : +49 (0) 37422 555 - 0
 Fax : +49 (0) 37422 555- 9999
 e-mail : info@warwick.de

| | | |
|-----------|----------------|----------------------------|
| | NAME | DATE |
| DRAWN | | Mittwoch, 4. Dezember 2019 |
| CHK'D | | A-01 |
| Scale 1:1 | SHEET 10 OF 12 | A4 |

M 60101 L

Copyright
 This drawing is the property of Warwick Gmbh & Co Music Equipment KG.
 The information given on it is protected by copyright and any form of copying or reproduction is strictly forbidden.